

SAVIN®

Digital Duplicator
3150DNP

Operating Instructions

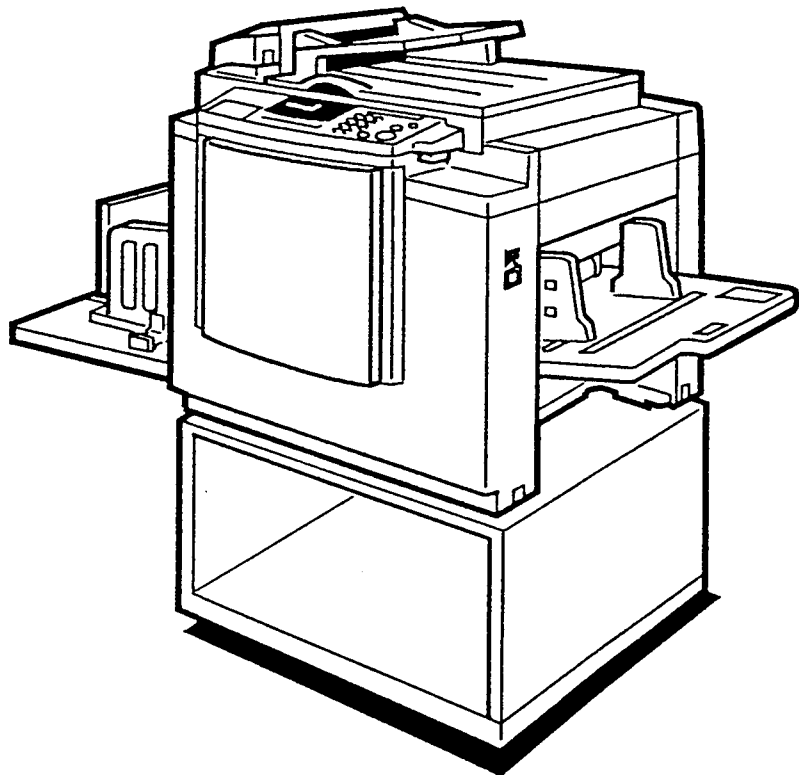

SAVIN CORPORATION

Southeast Regional Office
1670 Oakbrook Drive
Suite 350
Norgross, GA 30093
770--446-1227

Western Regional Office
4201 Spring Valley Road
Suite 1106
Dallas, TX 75244
972-392-9750

Eastern Regional Office
333 Ludlow Street
Stamford, CT 06902
203-967-5000

Central Regional Office
222 North LaSalle
Suite 830
Chicago, IL 60601
312-987-4230

Introduction

This manual contains detailed instructions on the operation and maintenance of this machine. To get maximum versatility from this machine all operators should carefully read and follow the instructions in this manual. Please keep this manual in a handy place near the machine.

Please read the Safety Information before using this machine. It contains important information related to USER SAFETY and PREVENTING EQUIPMENT PROBLEMS.



Notes:

Some illustrations may be slightly different from your machine.

Certain options may not be available in some countries. For details, please contact your local dealer.



Notes:

The model names of the machines do not appear in the following pages. Check the type of your machine before reading this manual.

- A4 drum: JP1010
- B4 drum: JP1050

Certain types might not be available in some countries. For details, please contact your local dealer.

Two kinds of size notation are employed in this manual. With this machine refer to the Metric version.

For good print quality, Ricoh recommends that you use genuine Ricoh master and ink.

Ricoh shall not be responsible for any damage or expense that might result from the use of parts other than genuine Ricoh parts in your Ricoh office product.

Power Source

220 – 240 V, 50/60 Hz, 1.5 A or more

Please be sure to connect the power cord to a power source as above. For details about power source, see ⇒ P.110 "Power connection".



Declaration of Conformity

"The Product complies with the requirements of the EMC Directive 89/336/EEC and the Low Voltage Directive 73/23/EEC."

In accordance with ISO Standard 7001, this machine uses the following symbols for the main switch:

- I** means **POWER ON.**
- O** means **POWER OFF.**

Safety Information

When using your machine, the following safety precautions should be always be followed.

Safety During Operation

In this manual, the following important symbols are used:

 **WARNING:**
Ignoring this warning could cause serious injury or even death.

 **CAUTION:**
Ignoring this caution could cause injury or damage to property.

Examples Of Indications



Symbols  mean a situation that requires you take care.



Do NOT carry out the operation represented by this symbol .
This example means "Do not take apart".



Symbols  mean you MUST perform this operation.
This example means "You must remove the wall plug".

⚠ WARNING:



- *Only connect the machine to the power source described on the inside front cover of this manual.*
- *Avoid multi-wiring.*
- *Do not damage, break or make any modifications to the power cord. Do not place heavy objects on it, pull it hard or bend it more than necessary. These actions could cause an electric shock or fire.*
- *Do not plug or unplug the power cord with your hands wet. Otherwise, an electric shock might occur.*



- *Make sure the wall outlet is near the machine and freely accessible so that in event of an emergency it can be unplugged easily.*



- *Do not remove any covers or screws other than those specified in this manual. Some parts of the machine are at a high voltage and could give you an electric shock. When the machine needs to be checked, adjusted, or repaired, contact your service representative.*
- *Do not take apart or attempt any modifications to this machine. There is a risk of fire, electric shock, explosion or loss of sight.*



- *If the machine looks damaged or breaks down, smoke is coming out, there is a strange smell or anything looks unusual, immediately turn off the main switch then unplug the power cord from the wall. Do not continue using the machine in this condition. Contact your service representative.*
- *If metal, liquid or foreign matter falls into the machine, turn off the main switch and unplug the main power cord. Contact your service representative. Do not keep using the machine with a fault or defect.*



- *Do not put any metal objects or containers holding water (e.g. vases, flowerpots, glasses) on the machine. If the contents fall inside the machine, a fire or electric shock could occur.*

⚠ CAUTION:



- *Keep the machine away from humidity and dust. A fire or an electric shock might occur.*
- *Do not place the machine on an unstable or tilted surface. If it topples over, it could cause injury.*



- *After you move the machine, fix it with the caster fixture. Otherwise, the machine might move or come down to cause a personal injury.*



- *When you move the machine, unplug the power cord from the wall outlet to avoid fire or electric shock.*
- *When the machine will not be used for a long time, unplug the power cord.*

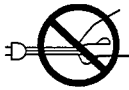

- *When you pull out the plug from the socket, grip the plug to avoid damaging the cord and causing fire or electric shock.*



- *If you use the machine in a confined space, make sure there is a continuous air turnover.*



- *Do not reuse stapled paper. Do not use aluminum foil, carbon-containing paper or other conductive paper. Otherwise, a fire might occur.*



- *This machine has been tested for safety using this supplier's parts and consumables. We recommend you only use these specified supplies.*



- *This equipment is only to be installed by a qualified service personnel.*



- *Deliver to collection point for waste products. Do not be disposed of via domestic refuse collection.*



- *If ink comes into contact with your eyes, rinse immediately in running water. In the case of any abnormal symptoms, consult a doctor.*



- *Keep the ink or ink container out of reach of children.*



- *If ink is ingested, force vomiting by drinking a strong saline solution and consult a doctor immediately.*



- *Be careful not to cut yourself on any sharp edges when you reach inside the machine to remove misfed sheets of paper or masters.*



- *Do not touch the belt at the end of the paper delivery table. Do not insert your hands under the paper feed table or the paper delivery table. You might be injured.*

How To Read This Manual

Symbols

In this manual, the following symbols are used:

 **WARNING:**

This symbol indicates a potentially hazardous situation that might result in death or serious injury when you misuse the machine without following the instructions under this symbol. Be sure to read the instructions, all of which are described in the Safety Information section.

 **CAUTION:**

This symbol indicates a potentially hazardous situation that might result in minor or moderate injury or property damage that does not involve personal injury when you misuse the machine without following the instructions under this symbol. Be sure to read the instructions, all of which are described in the Safety Information section.

* The statements above are notes for your safety.

 **Important**

If this instruction is not followed, paper might be misfed, originals might be damaged, or data might be lost. Be sure to read this.

 **Preparation**

This symbol indicates the prior knowledge or preparations required before operating.

 **Note**

This symbol indicates precautions for operation, or actions to take after misoperation.

 **Limitation**

This symbol indicates numerical limits, functions that cannot be used together, or conditions in which a particular function cannot be used.

 **Reference**

This symbol indicates a reference.

[]

Keys that appear on the machine's panel display.

[]

Keys built into the machine's operation panel.

What You Can Do With This Machine

- ❖ **Standard Printing**
See ⇒ P.5 “*Standard Printing*”.
- ❖ **Adjusting The Print Image Position**
See ⇒ P.8 “*Adjusting The Print Image Position*”.
- ❖ **Adjusting The Print Image Density**
See ⇒ P.10 “*Adjusting The Print Image Density*”.
- ❖ **Making Half-tone Prints**
See ⇒ P.11 “*Tint Mode—Making Half-tone Prints*”.
- ❖ **Making Clear Prints**
See ⇒ P.12 “*Use the [Fine] key to make clear prints.*”.
- ❖ **Changing The Print Speed**
See ⇒ P.13 “*Changing The Printing Speed*”.
- ❖ **Reducing And Enlarging Using Preset Ratios**
See ⇒ P.15 “*Preset Reduce/Enlarge—Reducing And Enlarging Using Preset Ra-
tios*”.

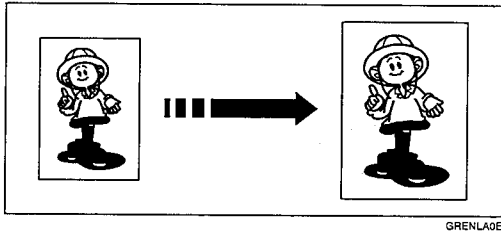
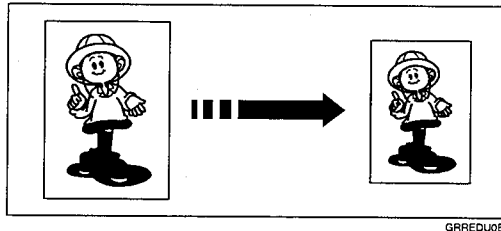

- ❖ **Erasing Center And Edge Margins**
See ⇒ P.17 “*Center/Edge Erase—Erasing Center And Edge Margins*”.

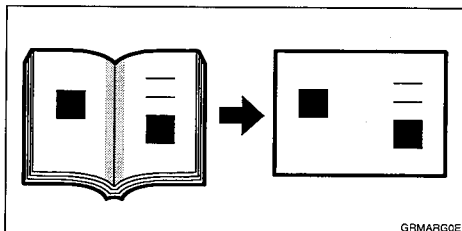

❖ **Erasing Edge Margins**

See ⇒ P.19 *"Edge Erase—Erasing Edge Margins"*.

❖ **Erasing The Shadow Of Pasted Originals**

See ⇒ P.21 *"Paste Shadow Erase—Erasing The Shadow Of Pasted Originals"*.

❖ **Printing On Thick Or Thin Paper**

See ⇒ P.22 *"Printing On Thick Or Thin Paper"*.

❖ **Selecting Original Type**

See ⇒ P.23 *"Selecting Original Type"*.

❖ **Ink Saving**

See ⇒ P.24 *"Economy Mode—Ink Saving"*.

❖ **Printing From Several Originals At Once**

See ⇒ P.25 *"Auto Cycle—Printing From Several Originals At Once"*.

❖ **Group Printing From The Same Original**

See ⇒ P.27 *"Class Mode—Group Printing From The Same Original"*.

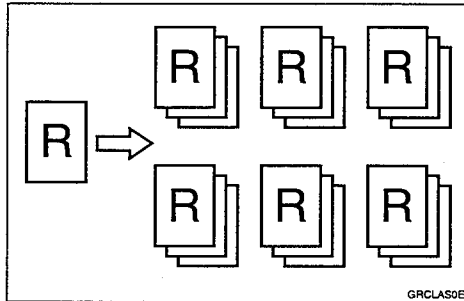

❖ **Group Printing From Different Originals**

See ⇒ P.29 *"Memory Mode—Group Printing From Different Originals"*.

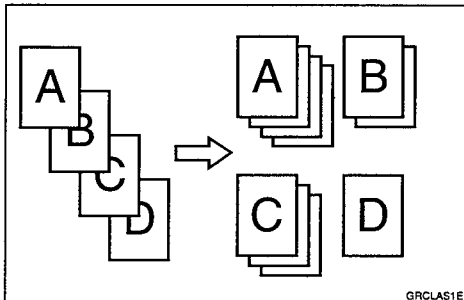

❖ **Combining Originals Into One Print**

See ⇒ P.32 *“Combine Copies—Combining 2 Originals Into One Print”*.

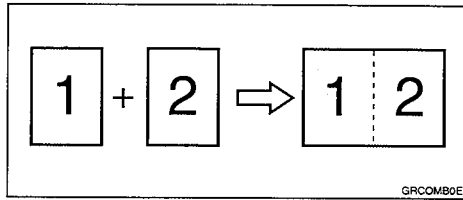

❖ **Skip Feed Printing**

See ⇒ P.35 *“Skip Feed Printing”*.

❖ **Storing Your Print Settings In Memory**

See ⇒ P.36 *“Program—Storing Your Print Settings In Memory”*.

❖ **Printing Secret Documents**

See ⇒ P.40 *“Security Mode—Printing Secret Documents”*.

❖ **Making Color Prints**

See ⇒ P.49 *“Making Color Prints”*.

❖ **Printing In Two Colors**

See ⇒ P.51 *“Printing In Two Colors”*.

Guide To Components

Machine Exterior

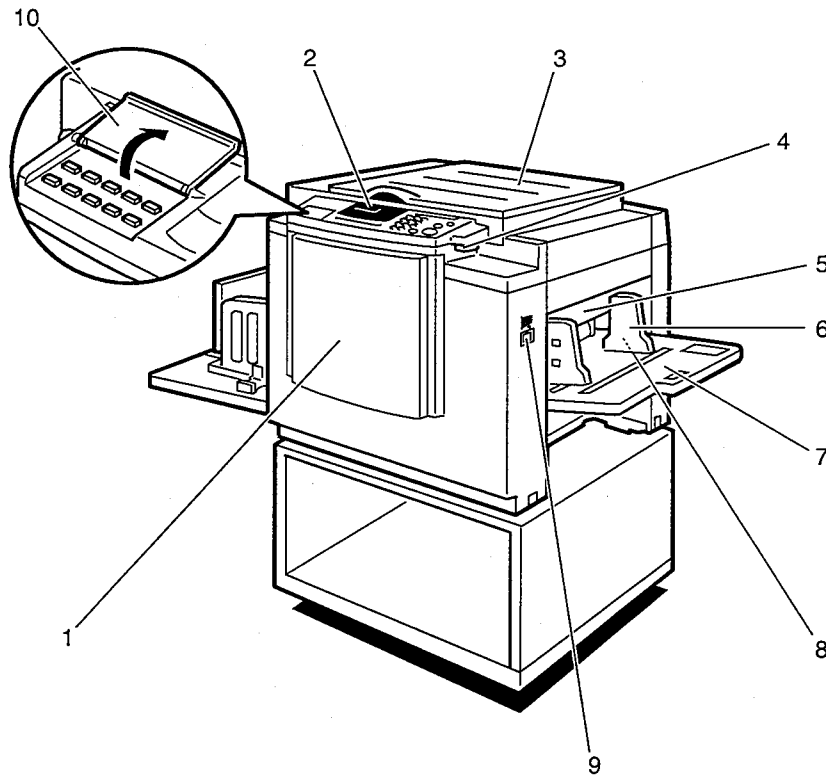

TSU401EE

1. Front Door

Open for access to the inside of the machine.

2. Operation Panel

Operator controls and indicators are located here. See ⇒ P.xiii "Operation Panel".

3. Platen Cover

Lower this cover over an original before printing.

4. Original Table Release Lever

Use to open the original table unit when installing the master.

5. Feed Roller Pressure Lever

Use to adjust the contact pressure of the paper feed roller according to paper thickness.

6. Paper Feed Side Plates

Use to prevent paper skew.

7. Paper Feed Table

Set paper on this table for printing.

8. Side Table Fine Adjusting Dial

Use to shift the paper feed table side-ways.

9. Paper Feed Table Down key

Press to lower the paper feed table.

10. Behind Cover

Flip up when you use the keys underneath.

Machine Interior

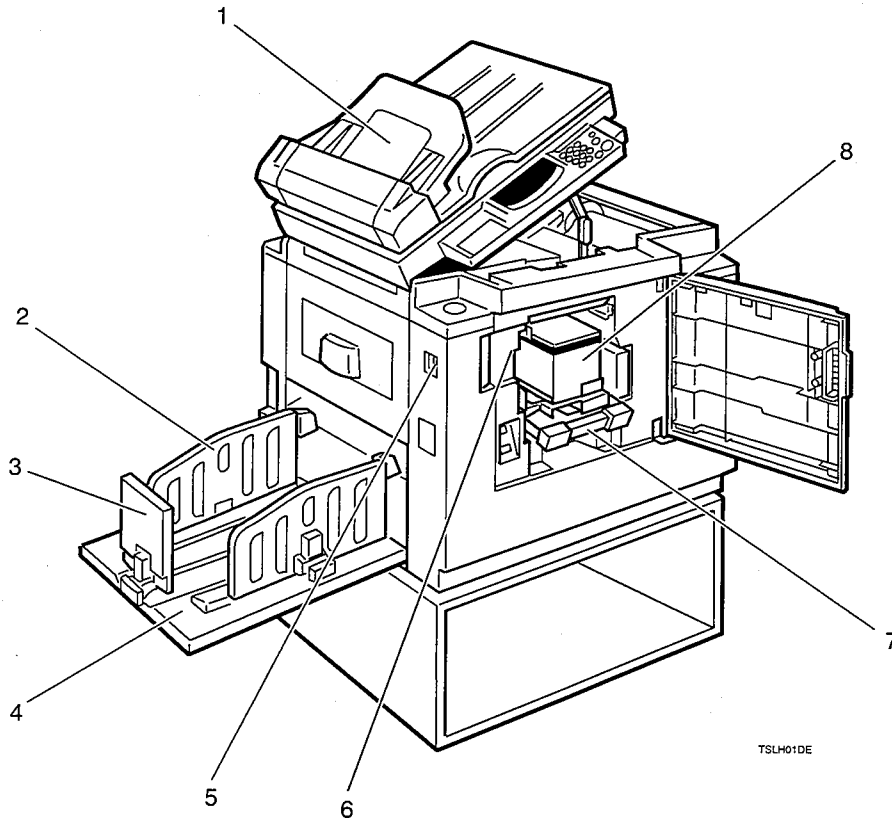

1. Document Feeder (Option)

Originals inserted into the document feeder are individually and automatically fed onto and removed from the exposure glass. See ⇒ P.41 "Printing Using The Optional 30 Originals Document Feeder".

2. Paper Delivery Side Plates

Use to align the prints on the paper delivery table.

3. Paper Delivery End Plate

Use to align the leading edge of prints.

4. Paper Delivery Table

Completed prints are delivered here.

5. Main Switch

Use to turn the power on or off.

6. Drum Unit

The master is wrapped around this unit.

7. Drum Unit Lock Lever

Lift to unlock and pull out the drum unit.

8. Ink Holder

Set the ink cartridge in this holder.

Options

❖ 30 Originals Document Feeder

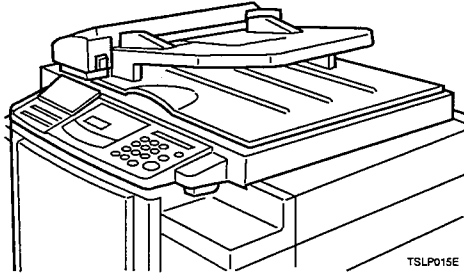

Note

Other options:

- Color Drum
- Tape Dispenser
- Key Counter

This page is intentionally blank.

Operation Panel

Keys

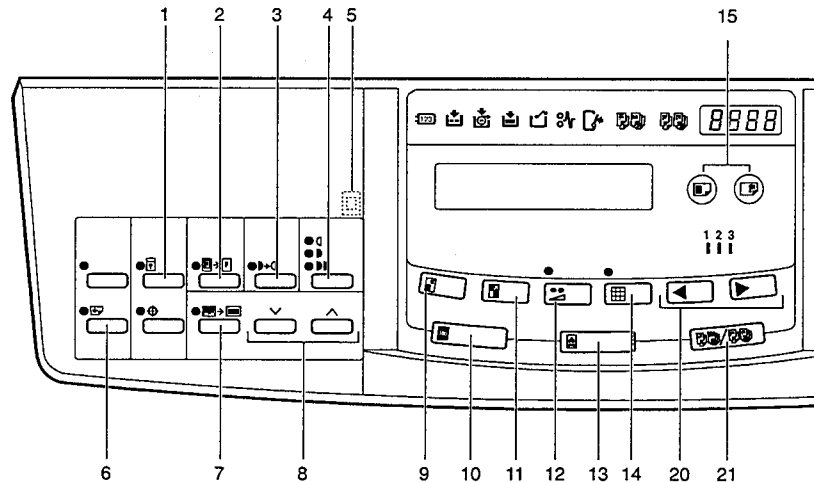

1. [Security] key

Press to make prints of secret documents. See ⇒ P.40 "Security Mode—Printing Secret Documents".

2. [Paste Shadow Erase] key

Press to erase the shadow of pasted originals. See ⇒ P.21 "Paste Shadow Erase—Erasing The Shadow Of Pasted Originals".

3. [Tint] key

Press to make half-tone prints. See ⇒ P.11 "Tint Mode—Making Half-tone Prints".

4. [Image Density] key

Press to make prints darker or lighter. See ⇒ P.10 "Adjusting The Print Image Density".

5. Check Indicator

This indicator lights when you have selected one or more of the functions accessed by lifting the cover and pressing the keys underneath (e. g. [Security] key, [Paste Shadow Erase] key etc.).

This lets you know whether one or more of these functions is selected, even if the cover is lowered.

6. [Skip Feed] key

Press to select skip feed printing. See ⇒ P.35 "Skip Feed Printing".

7. [Center/Edge Erase] key

Press to print book originals that have a solid image on the center or edges. See ⇒ P.17 "Center/Edge Erase—Erasing Center And Edge Margins".

8. [V] and [^] keys (Scroll keys)

Press to select size and direction of paper or original in Center/Edge Erase.

9. [Reduce] key

Press to reduce the image. See ⇒ P.15 "Preset Reduce/Enlarge—Reducing And Enlarging Using Preset Ratios".

10. [Full Size] key

Press to make full size prints.

11. [Enlarge] key

Press to enlarge the image. See ⇒ P.15 "Preset Reduce/Enlarge—Reducing And Enlarging Using Preset Ratios".

12. [Economy] key

Press to save ink. See ⇒ P.24 "Economy Mode—Ink Saving".

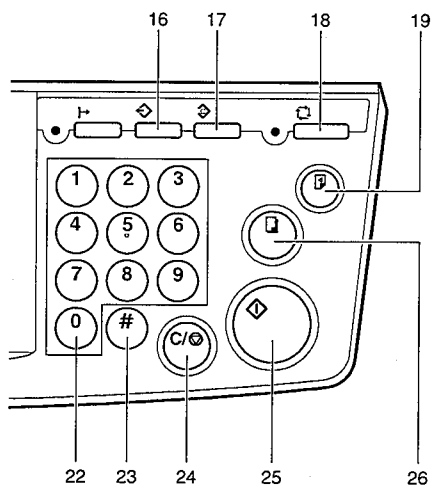

TSL5022E

13. [Type of Original] key

Press to select Letter, Photo, or Letter/Photo mode. See ⇒ P.23 "Selecting Original Type".

14. [Fine] key

Press to select the fine image. See ⇒ P.12 "Fine Mode—Making Clear Prints".

15. [Image Position] key

Press to shift the image forwards or backwards. See ⇒ P.8 "Adjusting The Print Image Position".

16. [Program] key

Press to input or recall user programs. See ⇒ P.36 "Program—Storing Your Print Settings In Memory".

17. [Clear Modes] key

Press to clear the previously entered job settings.

18. [Auto Cycle] key

Use to process the master and make prints automatically. See ⇒ P.25 "Auto Cycle—Printing From Several Originals At Once".

19. [Proof] key

Press to make proof prints.

20. [◀] and [▶] keys (Speed keys)

Press to adjust the printing speed. See ⇒ P.13 "Changing The Printing Speed".

21. [Memory/Class] key

Press to select Memory or Class mode. See ⇒ P.27 "Class Mode—Group Printing From The Same Original" or ⇒ P.29 "Memory Mode—Group Printing From Different Originals".

22. [Number] keys

Press to enter the desired number of prints and data for selected modes.

23. [#] key

Use to enter data in selected modes.

24. [Clear/Stop] key

While entering numbers, press to cancel a number you have entered.

While copying, press to stop copying.

25. [Start] key

Press to make a master.

26. [Print] key

Press to start printing.

Indicators

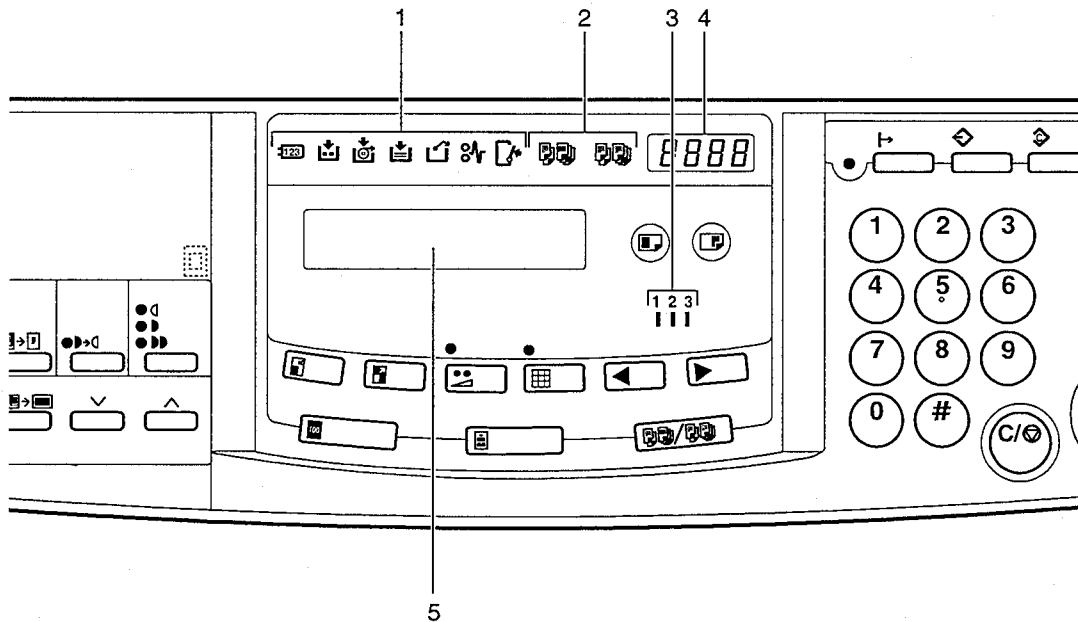

1. Error Indicators

These indicators are lit when a non-standard condition occurs within the machine.

2. Memory/Class Indicator

Shows the number entered in Memory or Class mode.

3. Speed Indicators

These indicators show the printing speed that is selected.

4. Counter

Displays the number of prints entered. While printing, it shows the number of prints remaining.

5. Guidance Display

Display the machine's condition.

TABLE OF CONTENTS

1. OPERATION

Printing Paper	1
Originals	2
Preparation For Printing	3
Loading Paper.....	3
Setting Up The Paper Delivery Table.....	4
Standard Printing	5
Restoring Paper Feed And Paper Delivery Tables	7
Adjusting The Print Image Position	8
Shifting The Print Image Position Forward Or Backward.....	8
Shifting The Print Image Position To The Right Or Left.....	8
Adjusting The Print Image Density	10
Before Making A Master.....	10
After Making A Master.....	10
Tint Mode—Making Half-tone Prints	11
Fine Mode—Making Clear Prints	12
Changing The Printing Speed	13
Stopping The Machine During The Multi-print Run	14
When You Want To Stop The Machine During The Multi-print Run And Print The Next Original.....	14
When You Want To Change The Number Of Prints Entered Or Check The Completed Prints.....	14
Preset Reduce/Enlarge—Reducing And Enlarging Using Preset Ratios	15
Center/Edge Erase—Erasing Center And Edge Margins	17
Edge Erase—Erasing Edge Margins	19
Paste Shadow Erase—Erasing The Shadow Of Pasted Originals	21
Printing On Thick Or Thin Paper	22
Printing On Thick Paper.....	22
Printing On Thin Paper.....	22
Selecting Original Type	23
Economy Mode—Ink Saving	24
Auto Cycle—Printing From Several Originals At Once	25
Class Mode—Group Printing From The Same Original	27
Memory Mode—Group Printing From Different Originals	29
Combine Copies—Combining 2 Originals Into One Print	32
Skip Feed Printing	35
Program—Storing Your Print Settings In Memory	36

Storing Your Settings	36
Recalling A Program	37
Protecting A Program.....	38
Removing Program Protection	39
Security Mode—Printing Secret Documents	40

2. OPTIONAL FUNCTIONS

Printing Using The Optional 30 Originals Document Feeder	41
Document Feeder Exterior	41
Originals	41
Setting Originals In The Document Feeder.....	42
Combine Copies With The Document Feeder	44
Memory Mode With The Document Feeder	45
Color Printing Using The Optional Color Drum.....	49
Making Color Prints.....	49
Changing The Color Drum Unit.....	49
Printing In Two Colors.....	51

3. SERVICE PROGRAM MODE

Accessing Service Programs.....	53
Changing The Settings Of Service Programs.....	54
Service Program Menu	55
User Codes.....	62
How To Set User Code Mode (# 120).....	62
How To Use User Code Mode	63
How To Check The User Code Counter (# 121).....	63
How To Clear The User Code Counter (# 122).....	64
How To Check The Total Number Of Masters And Prints Made Under All User Codes (# 123).....	65
How To Clear The User Code Total Counter (# 124).....	66

4. REPLENISHING SUPPLIES

Loading Paper On The Paper Feed Table	69
Replenishing Paper.....	69
Changing The Paper Size	70
When The Add Ink Indicator (ⓘ) Blinks.....	71
Master Roll Replacement.....	74
Placing A New Roll Of Tape In The Tape Dispenser (Option)	76

5. WHAT TO DO IF SOMETHING GOES WRONG

If Your Machine Does Not Operate As You Want	79
⚠ Clearing Misfeeds.....	82

“OJ” + “ORIGINAL JAM. REMOVE ORIGINAL”	82
“OJ” + “PAPER FEED JAM. REMOVE JAMMED PAPER”	85
“OJ” + “MASTER FEED JAM. REMOVE JAMMED MASTER”	88
“OJ” + “PAPER WRAP JAM. REMOVE JAMMED PAPER”	89
“OJ” + “MASTER EJECT JAM. REMOVE JAMMED MASTER”	92
“OJ” + “DELIVERY JAM. REMOVE JAMMED PAPER”	94
When The Open Cover/Unit Indicator (☐*) Blinks.....	95
When The Master Eject Indicator (☐) Blinks.....	97
When Other Indicators Blink.....	98
When The Prints Are Thrown Over The Paper Delivery Table.....	99
Poor Printing.....	100
Dirt On The Back Side Of Paper	100
Dirt On The Front Side Of Paper (Black Line/Stain)	102
White Prints Or Incomplete Prints	102

6. REMARKS

Operation Notes.....	105
General Cautions	105
Print Paper	107
Originals	107
Where To Put Your Machine.....	109
Environmental Conditions	109
Power connection.....	110
Access to machine	111
Maintaining Your Machine.....	112
Main Frame	112
Optional Document Feeder	113
Combination Chart.....	114

7. SPECIFICATION

Main Frame.....	115
30 Originals Document Feeder.....	118
Consumables.....	119
INDEX.....	120

1. OPERATION

Printing Paper

The following types of print paper are not recommended for this machine.

- Paper smaller than 90 mm × 148 mm, 3.6" × 5.9"
- Paper larger than 268 mm × 388 mm, 10.5" × 15.2"
- Paper heavier than 157.0 g/m², 41.7 lb
- Paper lighter than 47.1 g/m², 12.5 lb
- Roughly-cut paper
- Paper of different thickness in the same stack
- Buckled or curled paper
- Low stiffness paper

Correct curls in the paper before setting it in the machine. When you cannot correct the paper curl, stack the paper with the curl face down. Otherwise the paper might wrap around the drum or stains might appear.

Store paper where it will not curl or absorb moisture. Use paper soon after it is unpacked.

Only use paper where the leading edge has two right angle corners, as shown below.

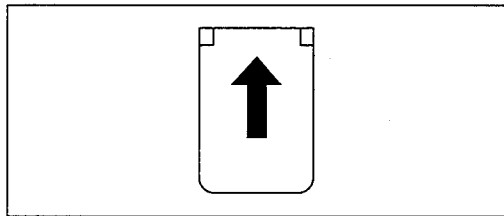

GRPRINDE

Originals

1

Note

- Originals that can be set on the exposure glass are as follows:
 - Maximum size: 257 × 364 mm, 10.2" × 14.4"
 - Maximum total thickness: 30 mm, 1.1"
 - Maximum total weight: 5 kg, 11.0 lb
- If you use paste-up originals, make sure the pasted parts hold firmly to the base sheet and press the **[Paste Shadow Erase]** key. If the thickness of the paste-up original is more than 0.1 mm and the space between the pasted parts is less than 2 mm, 0.08", a shadow might appear on the prints.
- If you use originals that have bold letters or solid images at the leading edges, you might get prints with dirty edges. In this case, insert the widest margin first, or raise the printing speed.
- The first 5 mm, 0.2" of the leading edge cannot be printed. Make sure the leading edge margin is at least 5 mm, 0.2".

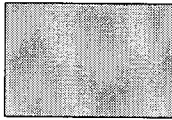
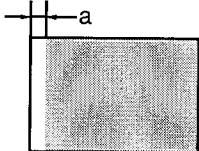
Original	Print
	

- a: 5 mm, 0.2"

Preparation For Printing

Loading Paper

- 1 Carefully open the paper feed table.

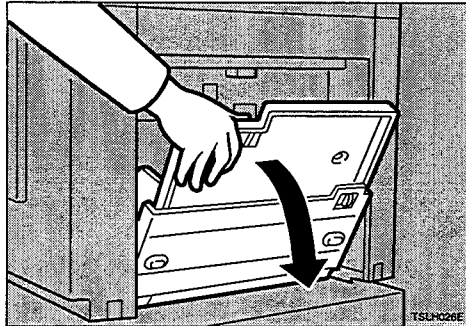

- 2 Put the paper feed side plates lock lever. Adjust the side plates to match the paper size.

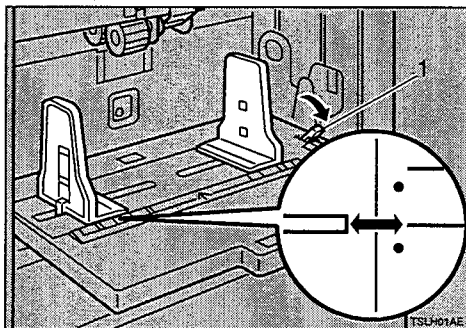

1: Paper Feed Side Plates Lock Lever

- 3 Place the paper on the paper feed table.

1

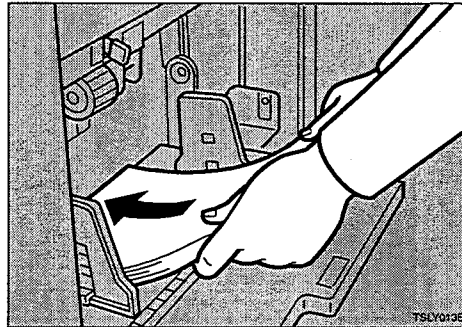

Note

- Correct the paper curl before setting the paper. If you cannot do so, stack the paper with the curl face down as shown.

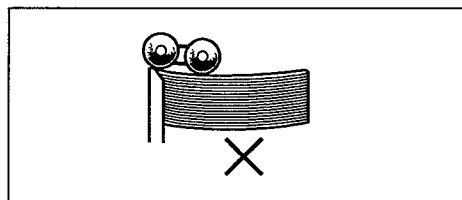
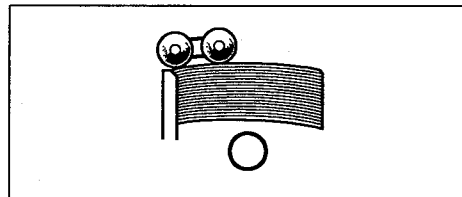

- 4** Make sure that the paper feed side plates touch the paper lightly. Put back the lock lever.

1

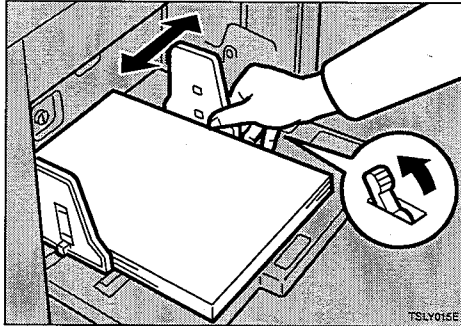

- 2** Lift the paper delivery end plate and move it to match the print paper size.

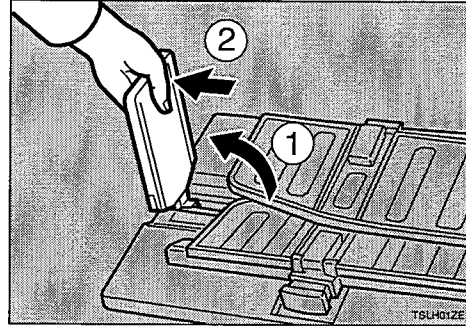

Setting Up The Paper Delivery Table

- 1** Open the paper delivery table.

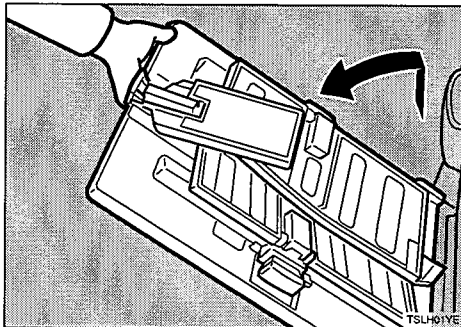

- 3** Lift the paper delivery side plates and adjust them to the paper size.

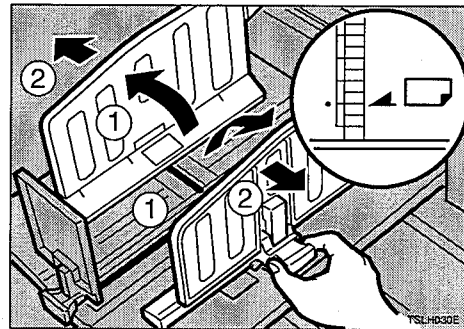

- 4** Turn on the main switch.

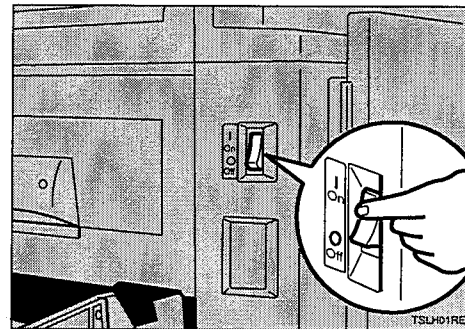

Reference

When the prints are not delivered in a neat stack, see ⇒ P.99 "When The Prints Are Thrown Over The Paper Delivery Table".

Standard Printing

Printing

In this manual, the word, "Printing" is used as opposed to "Copying" in order to distinguish between the process that your machine uses to make prints, and the process used by a standard copier machine.

A standard copier scans in the original for each copy set made. This machine, however, scans in your original once and makes multiple prints from this master.

This chapter describes the basic printing operations that your machine is capable of.

1 Lift the platen cover.

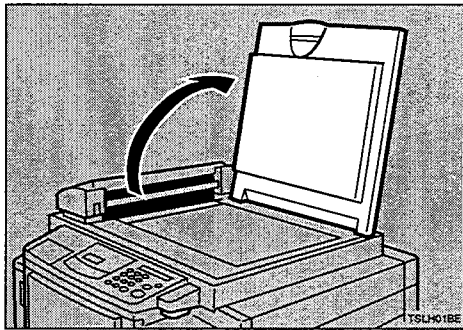

2 Set the original face down on the exposure glass. The original

should be centered according to the size marks on the right scale.

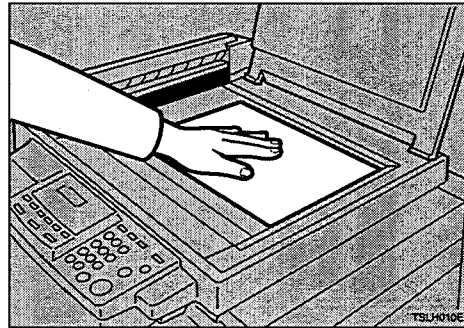

3 Lower the platen cover.

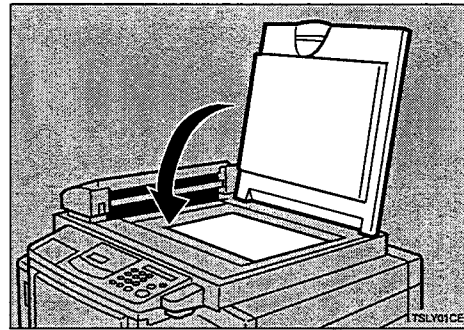

4 Enter the number of prints required with the [Number] keys.

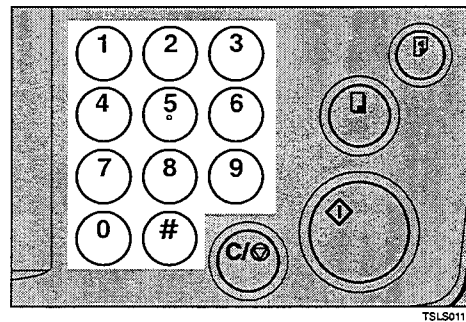

Note

- Up to 9999 prints can be entered at one time.
- To change the number entered, press the [Clear/Stop] key and enter the new number.

1

5 Press the **[Start]** key.

1

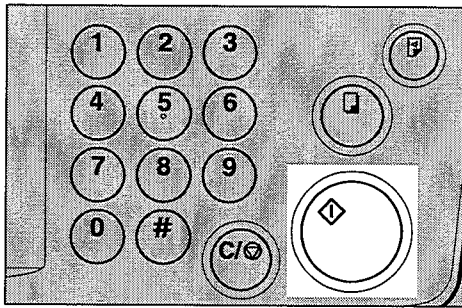

TSL5012E

A trial print is delivered to the paper delivery table.

6 Press the **[Proof]** key and check the image density and the image position of the proof print.

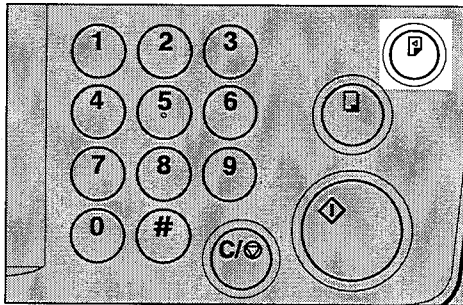

TSL5013E

Note

- If the image position is not correct, adjust it using the **[Image Position]** keys or the fine adjustment dial. See ⇒ P.8 "Adjusting The Print Image Position".
- If the image density is slightly dark or light, adjust the image density using the **[◀]** or **[▶]** key. See ⇒ P.10 "Adjusting The Print Image Density".

7 Press the **[Print]** key.

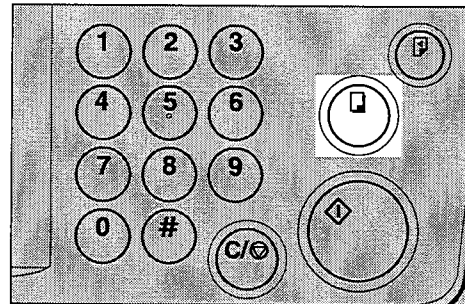

TSL5014E

Note

- After printing is completed, the same number of prints is automatically set for the next job.
- To stop the machine during the multi-print run, press the **[Clear/Stop]** key.
- To return the machine to the initial condition after printing, press the **[Clear Modes]** key.

Restoring Paper Feed And Paper Delivery Tables

- 1** Remove the paper from the paper feed table.

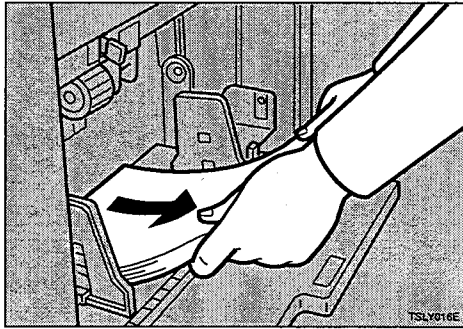

The paper feed table will lower.

- 2** Turn off the main switch.

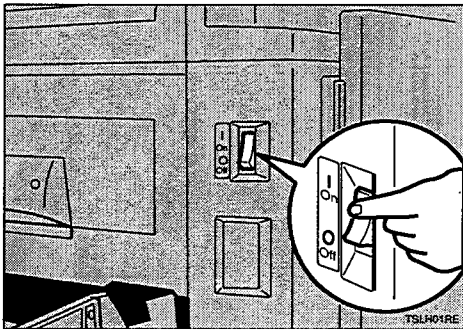

- 3** Close the paper feed table.

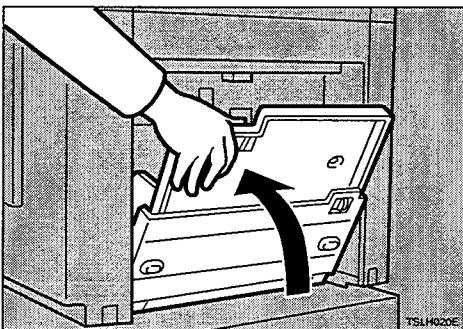

- 4** Move the end plate until the plate handle is flush with the end of the table.

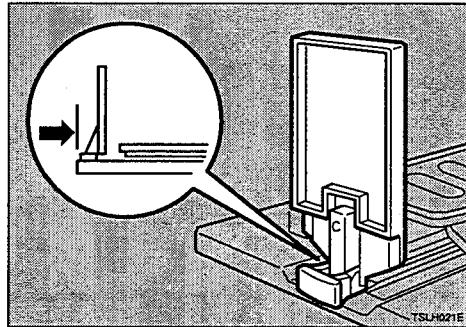

- 5** Lower the end plate.

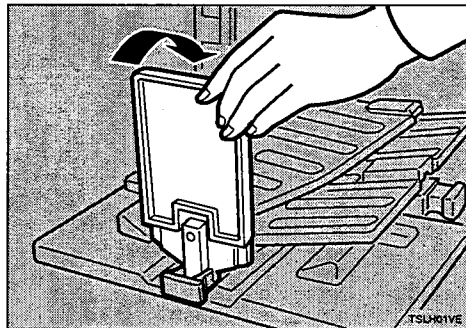

- 6** Move the side plates to the sides, then lower them.

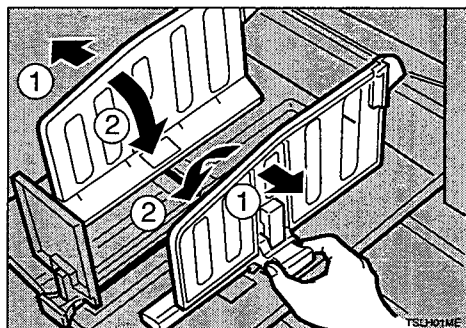

- 7** Close the table.

1

Adjusting The Print Image Position

1

You can adjust the print image position to suit your needs. There are two ways:

❖ **Shifting The Image Position Forward Or Backward**

Shift the image position using the [Image Position] keys.

❖ **Shifting The Image Position To The Right Or Left**

Shift the image position using the side table fine adjusting dial.

Note

❑ When you shift the image forwards, leave a margin (more than 5 mm, 0.2") at the leading edge. If there is no margin, paper might wrap around the drum and cause a misfeed.

❑ The right or left [Image Position] keys shift the image about 0.5 mm, 0.02" each time they are pressed. When the indicator changes, the image position shifts about 5 mm, 0.2".

Shifting The Print Image Position Forward Or Backward

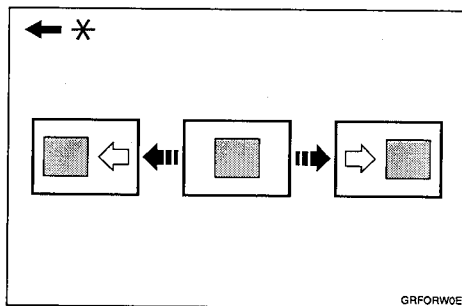

* Paper feed direction

1 Press the right [Image Position] key to move the image forwards, the left key to move it backwards.

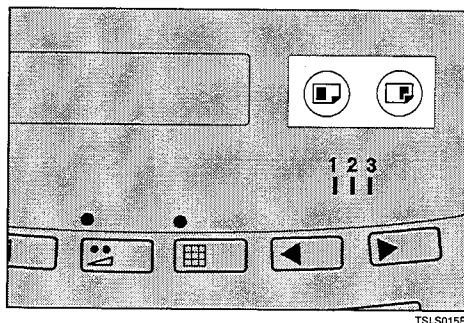

2 Press the [Proof] key to check the image position.

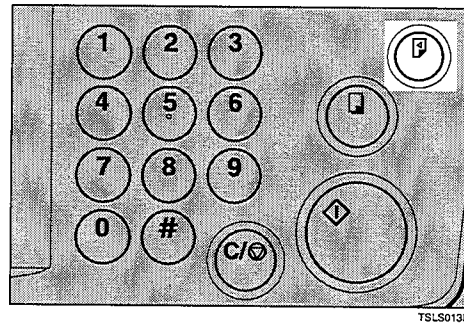

Shifting The Print Image Position To The Right Or Left

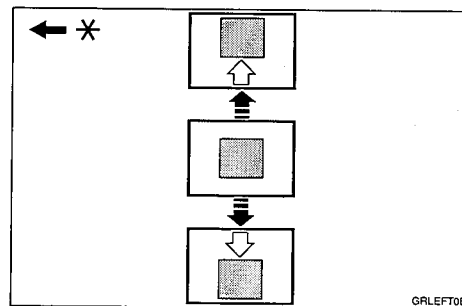

* Paper feed direction

1 Turn the side table fine adjusting dial as shown in the illustrations.

❖ Shifting the image to the right

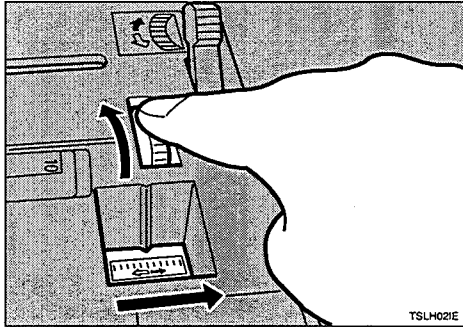

❖ Shifting the image to the left

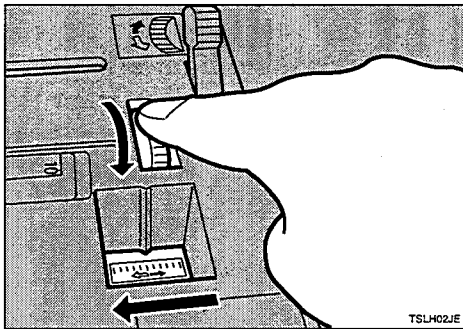

Note

- ❑ The image position can be shifted up to about 10 mm, 0.4" each way. Each division on the scale is 2 mm, 0.08".

2 Adjust the paper delivery side plates to the print paper position.

3 Press the [Proof] key to check the image position.

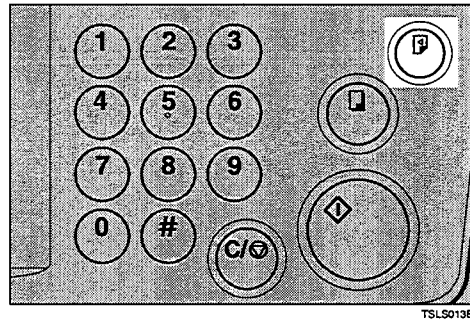

1

Adjusting The Print Image Density

1

You can adjust the print image density to suit your needs. There are two ways:

- ❖ **Before Making A Master**
Adjust the image density using the **[Image Density]** key.
- ❖ **After Making A Master**
Adjust the image density using the **[◀]** or **[▶]** key.

Before Making A Master

- 1 Use the **[Image Density]** key before pressing the **[Start]** key.

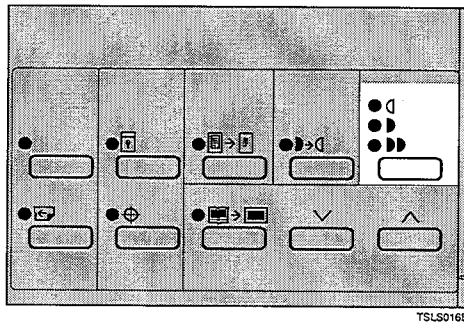

TSL5016E

After Making A Master

- 1 Press the **[◀]** or **[▶]** key. To increase the speed, press the **[▶]**

key. To reduce the speed, press the **[◀]** key.

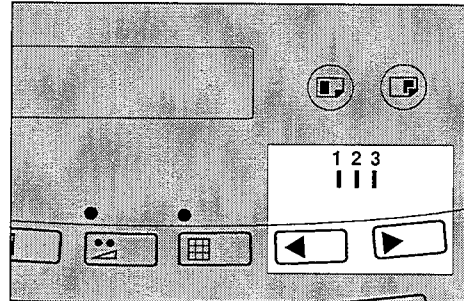

TSL5017E

Note

- ❑ The faster the printing speed becomes, the lighter the printing density is. If you want darker prints, decrease the printing speed.

Tint Mode—Making Half-tone Prints

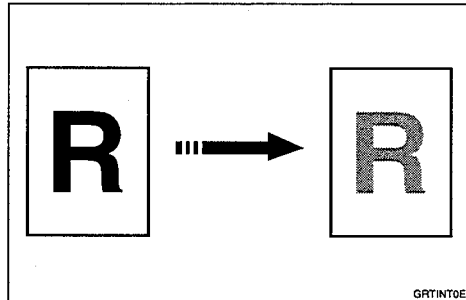

Use the **[Tint]** key to make half-tone prints.

- 1** Press the **[Tint]** key to select Tint mode.

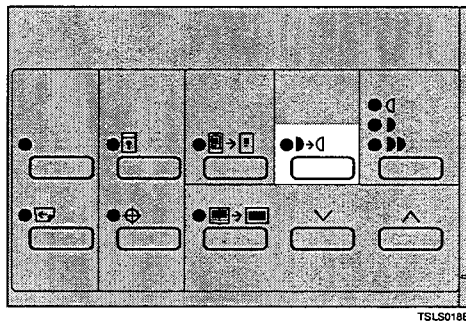

- 2** Set your originals on the exposure glass or in the optional document feeder.

- 3** Press the **[Start]** key.

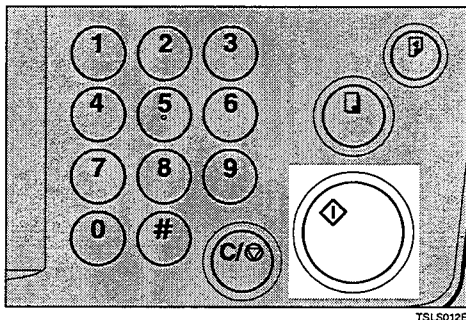

- 4** Check the image position of the trial or proof print.

Note

- If the image position is not correct, adjust it using the **[Image Density]** keys (see ⇒ P.8 “Adjusting The Print Image Position”) or the side table fine adjusting dial (see ⇒ P.8 “Shifting The Print Image Position To The Right Or Left”).

- 5** Enter the number of prints with the **[Number]** keys.

- 6** Press the **[Print]** key.

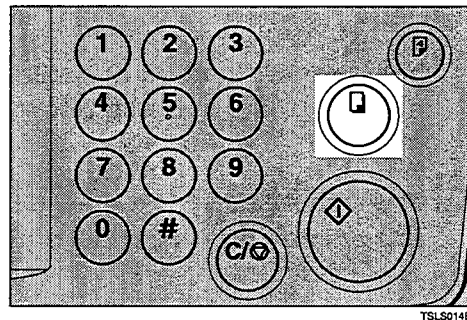

1

Fine Mode—Making Clear Prints

1

Use the **[Fine]** key to make clear prints.

- 1 Press the **[Fine]** key to select Fine mode.

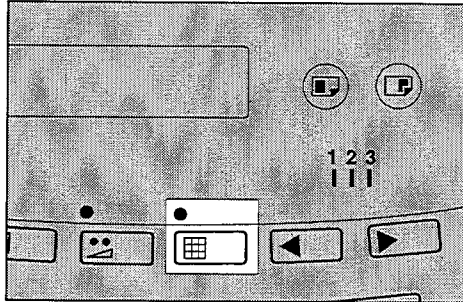

- 2 Set your originals on the exposure glass or in the optional document feeder.

- 3 Press the **[Start]** key. Check the image position of the trial or proof print.

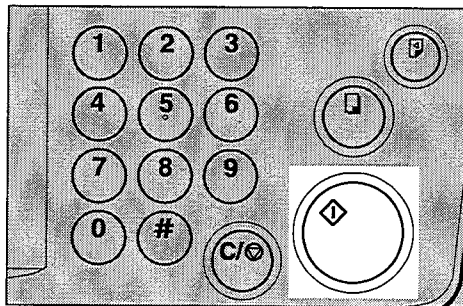

- 4 Enter the number of prints with the **[Number]** keys.

- 5 Press the **[Print]** key.

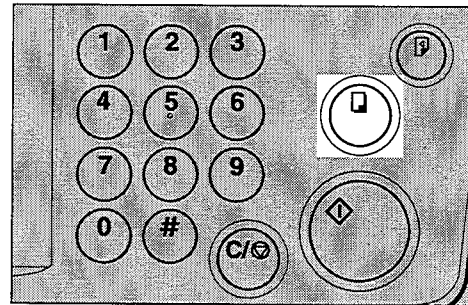

Note

- If the image position is not correct, adjust it using the **[Image Position]** keys (see ⇒ P.8 “Adjusting The Print Image Position”) or the side table fine adjusting dial (see ⇒ P.8 “Shifting The Print Image Position To The Right Or Left”).

Changing The Printing Speed

Use the [◀] or [▶] key to adjust the speed of the machine with the image density and printing paper.

- 1** Press the [▶] key to increase the speed and press the [◀] key to reduce the speed.

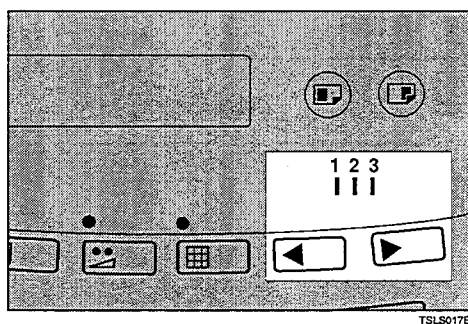

Note

- The following speeds are available:
 - Setting 0:
80 sheets/minute
 - Setting 1:
100 sheets/minute
 - Setting 2:
120 sheets/minute
- As a default setting, Setting 1 is selected.
- The faster the printing speed becomes, the lighter the printing density is, and vice versa.

Stopping The Machine During The Multi-print Run

1

When You Want To Stop The Machine During The Multi-print Run And Print The Next Original

1 Press the **[Clear/Stop]** key.

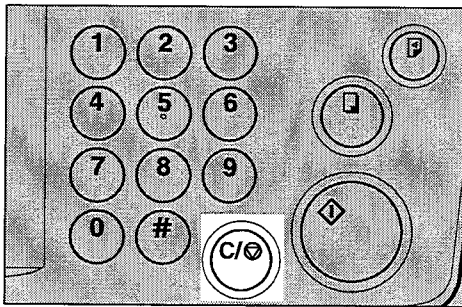

TSL501AE

2 Set the new original.

3 Enter the number of prints and press the **[Start]** key.

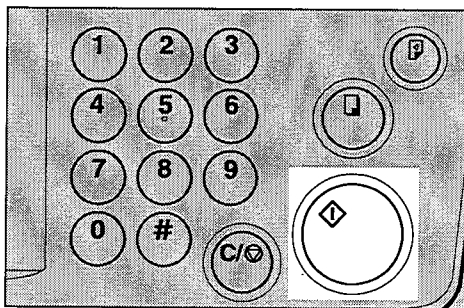

TSL5012E

When You Want To Change The Number Of Prints Entered Or Check The Completed Prints

1 Press the **[Clear/Stop]** key.

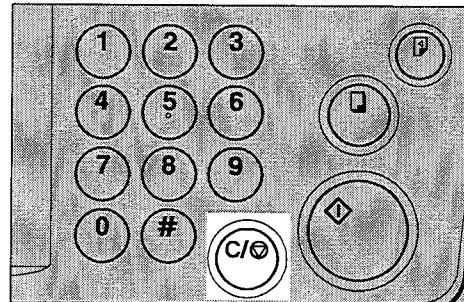

TSL501AE

2 Change the number of prints or check the completed prints.

Note

- When you change the number of prints, you can re-enter the number with the **[Number]** keys after pressing the **[Clear/Stop]** key.

3 Press the **[Print]** key.

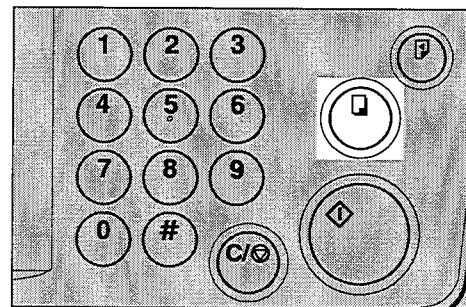

TSL5014E

Preset Reduce/Enlarge—Reducing And Enlarging Using Preset Ratios

1

You can select a preset ratio for printing.

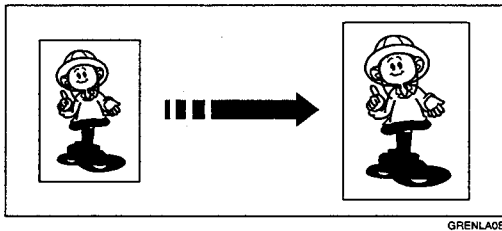
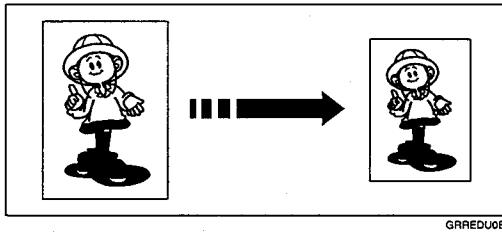

Prints can be reduced or enlarged as follows:

Reduction (Metric version)

Reduction Ratio	Original Size	Print Size
93 %	*1	
87 %	A5	B6
	A4	B5
82 %	B4	A4
	B5	A5
71 %	A4	A5
	B4	B5

*1 Select this ratio when you make prints with a lot of edge margins.

Reduction (Inch version)

Reduction Ratio	Original Size	Print Size
93 %	*1	
77 %	8 ¹ / ₂ "×14"	8 ¹ / ₂ "×11"
74 %	10"×14"	8 ¹ / ₂ "×11"
65 %	8 ¹ / ₂ "×11"	5 ¹ / ₂ "×8 ¹ / ₂ "

*1 Select this ratio when you make prints with a lot of edge margins.

Note

The center and the leading edge of the print image do not shift when a print image is made with this function.

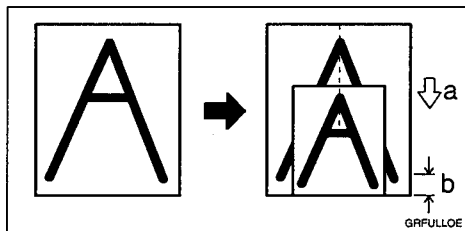

a: Paper Feed Direction

b: Constant

You can select one of 7 preset ratios (3 enlargement ratios, 4 reduction ratios).

You can select a ratio regardless of the size of an original or printing paper. With some ratios, parts of the image might not be printed or margins will appear on prints.

❖ Enlargement (Metric version)

Enlarge-ment Ratio	Original Size	Print Size
141 %	B5	B4
	A5	A4
122 %	A4	B4
	A5	B5
115 %	B5	A4
	B6	A5

❖ Enlargement (Inch version)

Enlarge-ment Ratio	Original Size	Print Size
155 %	5 ¹ / ₂ "×8 ¹ / ₂ "	8 ¹ / ₂ "×14"
129 %	5 ¹ / ₂ "×8 ¹ / ₂ "	8 ¹ / ₂ "×11"
121 %	8 ¹ / ₂ "×11"	11"×15"

1 Select the desired reduction or enlargement ratio using the [Reduce] key or the [Enlarge] key.

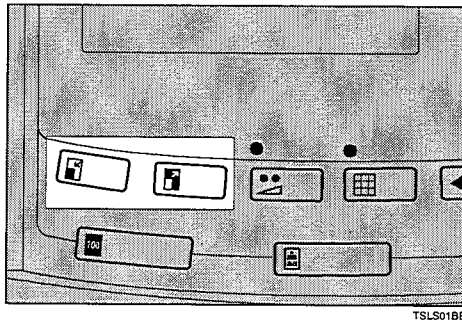

2 Make sure that the original and the print paper are the correct size.

3 Set your originals on the exposure glass or in the optional document feeder.

4 Press the [Start] key.

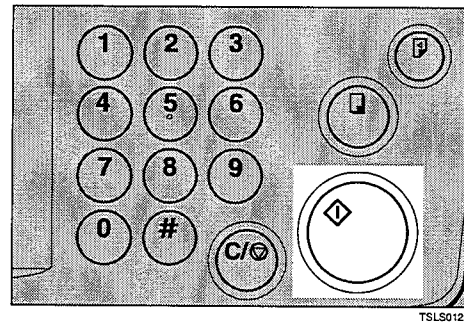

5 Check the image position of the trial or proof print.

Note

- If the image position is not correct, adjust it using the [Image Position] keys (see ⇒ P.8 "Shifting The Print Image Position Forward Or Backward") or the side table fine adjusting dial (see ⇒ P.8 "Shifting The Print Image Position To The Right Or Left").

6 Make your prints.

Center/Edge Erase—Erasing Center And Edge Margins

When printing from thick books, or similar originals, the binding margin at the center and the edges might appear on prints. To prevent this, follow the steps below.

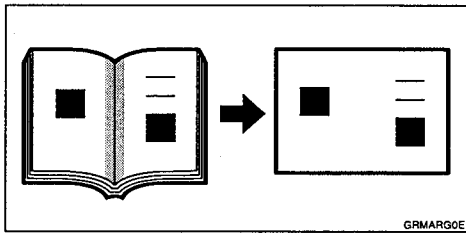

Note

- As a default setting, the paper sizes and directions that can be used are as follows:

Metric version	B4, A4, A5, A5, B5, B5
Inch version	8 1/2" x 14", 8 1/2" x 11", 5 1/2" x 8 1/2", 5 1/2" x 8 1/2"

- If you want to use other size originals, you can register the size using Service Program mode (See ⇒ P.55 "Service Program Menu").
- The margin width to be erased can be adjusted with Service Program mode (See ⇒ P.55 "Service Program Menu").

- Press the [Center/Edge Erase] key twice to select the Center/Edge Erase mode.

Check Indicator is blinking and  is shown in the guidance display.

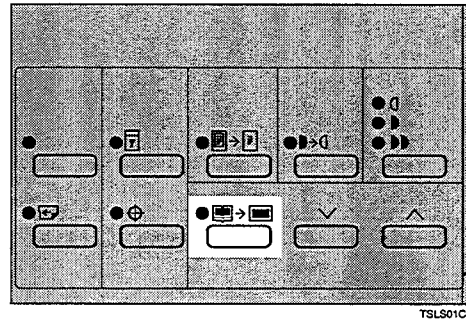

Note

- To cancel this mode, press the [Center/Edge Erase] key again.

- Press the [V] or [^] key to select the paper size and direction.

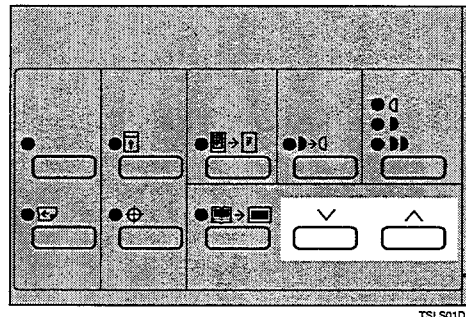

- 3** When you reach the desired paper size and direction, press the **[#]** key.

1

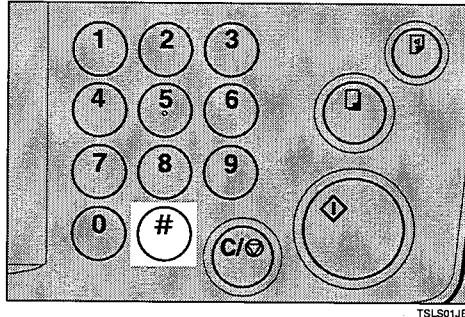

- 4** Set the book on the exposure glass.

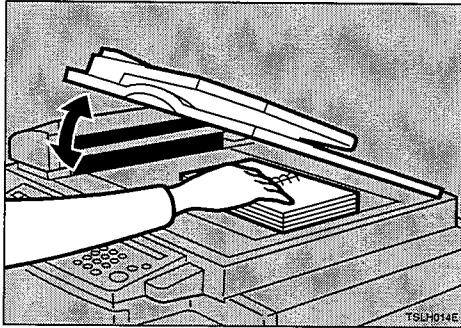

- 5** Press the **[Start]** key.

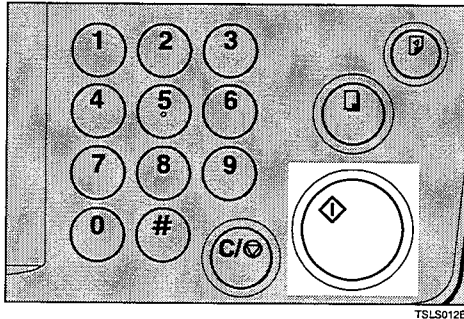

- 6** Check the image position of the trial or proof print.

Note

- If the image position is not correct, adjust it using the **[Image Position]** keys (see ⇒ P.8 "Adjusting The Print Image Position")

or the side table fine adjusting dial (see ⇒ P.8 "Shifting The Print Image Position To The Right Or Left").

- 7** Enter the number of prints with the **[Number]** keys.

- 8** Press the **[Print]** key.

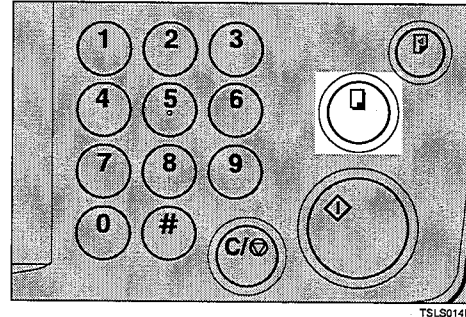

Edge Erase—Erasing Edge Margins

If you want to erase edge margins of a book original, follow the steps below.

Note

- As a default setting, the paper sizes and directions that can be used are as follows:

Metric version	B4, A4, A5, A5, B5, B5
Inch version	8 1/2" x 14", 8 1/2" x 11", 5 1/2" x 8 1/2", 5 1/2" x 8 1/2"

- If you want to use other size originals, you can register the size using Service Program mode (See ⇒ P.55 "Service Program Menu").
- The margin width to be erased can be adjusted with Service Program mode (See ⇒ P.55 "Service Program Menu").

1 Press the [Center/Edge Erase] key to select Edge Erase mode.

Check Indicator is blinking and  is shown in the guidance display.

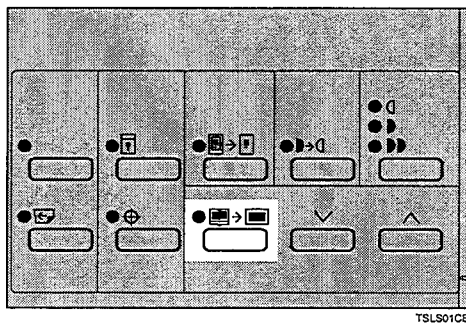

Note

- To cancel this mode, press the [Center/Edge Erase] key twice.

2 Press the [V] or [^] key to select the paper size and direction.

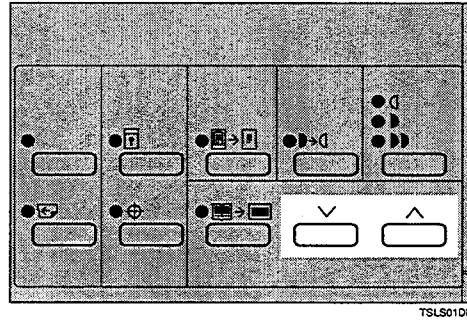

3 When you reach the desired paper size and direction, press the [#] key.

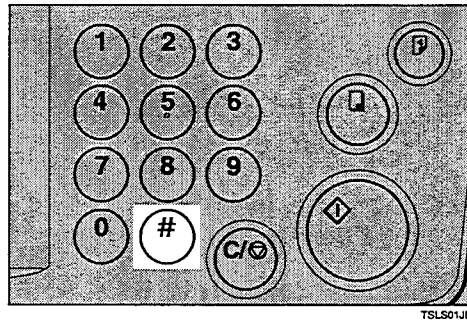

4 Set the book on the exposure glass.

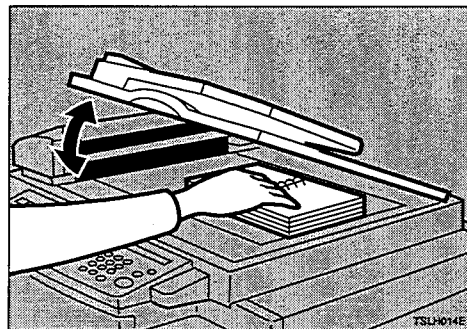

1

5 Press the **[Start]** key.

1

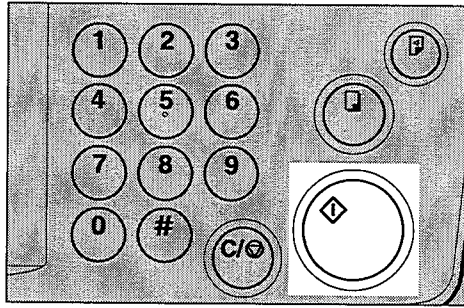

6 Check the image position of the trial or proof print.

Note

- If the image position is not correct, adjust it using the **[Image Position]** keys (see ⇒ P.8 “Adjusting The Print Image Position”) or the side table fine adjusting dial (see ⇒ P.8 “Shifting The Print Image Position To The Right Or Left”).

7 Enter the number of prints with the **[Number]** keys.

8 Press the **[Print]** key.

